

Wall panel between two existing walls

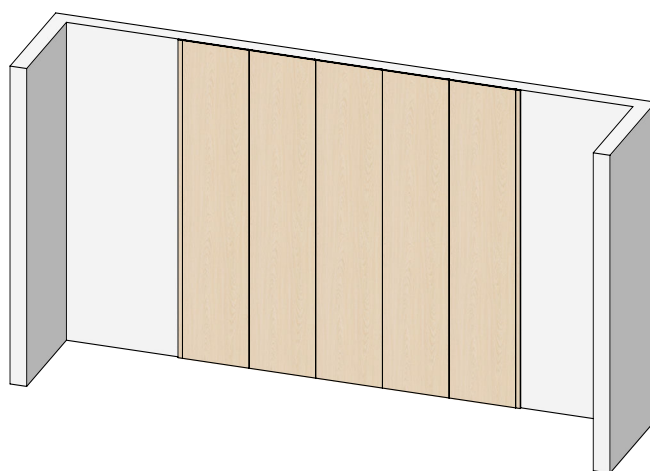

Panels with end strips

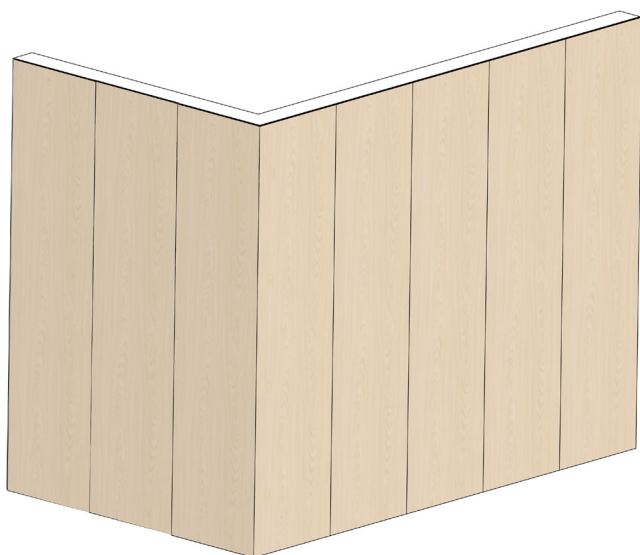

Installing panels with outer corners

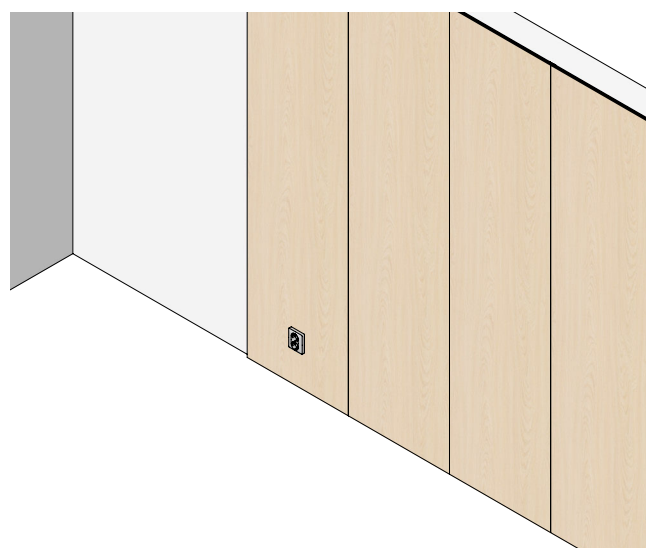





Panels with electrical sockets

CONTENTS

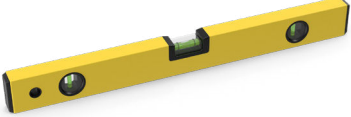
Tools & Accessories _____	3
Wall panel between two walls _____	4
Panels with end strips _____	9
Installing panels with outer corners	
Version 1 _____	12
Version 2 _____	14
Installing panels with electrical sockets	
Externally mounted electrical sockets _____	16
Recessed electrical sockets _____	18

TOOLS NEEDED:

 <p>Circular saw</p>	 <p>Spirit level</p>	 <p>Hack saw (only for LED strips)</p>
 <p>Screwdriver</p>	 <p>Tape measure</p>	 <p>Grab adhesive</p>

ENDA SVEN MOTÄRNINGAR/ELRITTSKOKETS:

 <p>Compass saw</p>	 <p>Drill (5mm)</p>	 <p>Hole saw drill bit</p>
---	---	---

ÖVRIGT BEHÖR

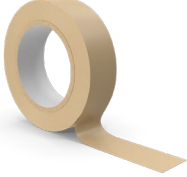
 <p>LED lighting</p>	 <p>Screws</p>	 <p>Tape</p>
---	---	---

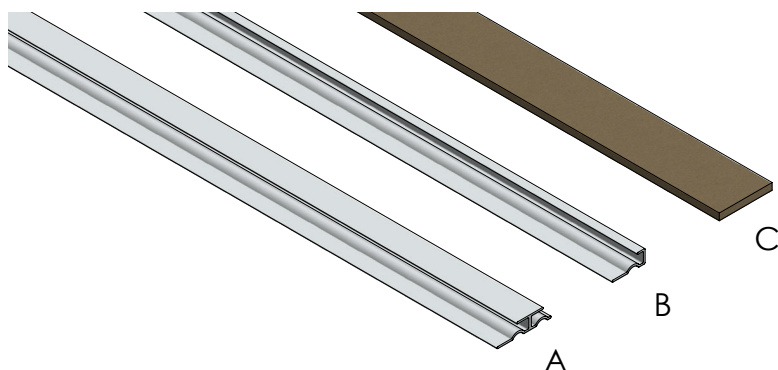

Accessories for installing our wall panels.

- A. JOINT profile
- B. START profile
- C. SPACER strip

WALL PANEL BETWEEN TWO WALLS



1



1. Measure the height of the existing wall. Saw the wall panel at the correct height using a circular saw or a shadow gap saw

2

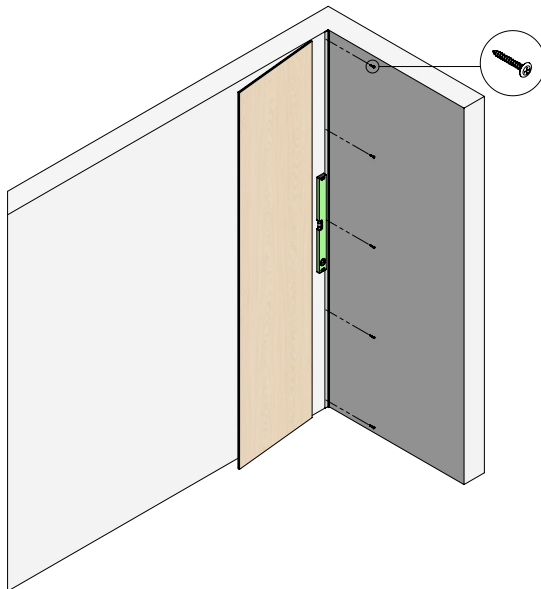

2. When installing between two existing walls, begin by screwing our START profile in place. Make sure the profile is level by using a spirit level. Screw the profile into place keeping 50 mm from the upper edge and the lower edge, then evenly distribute the profiles in-between.

How many screws to use for the START profile: 2,400 mm = 5 screws and 2,960 mm = 6 screws.

Predrill holes in our profiles using a 5 mm drill bit before placing them on the wall.

3

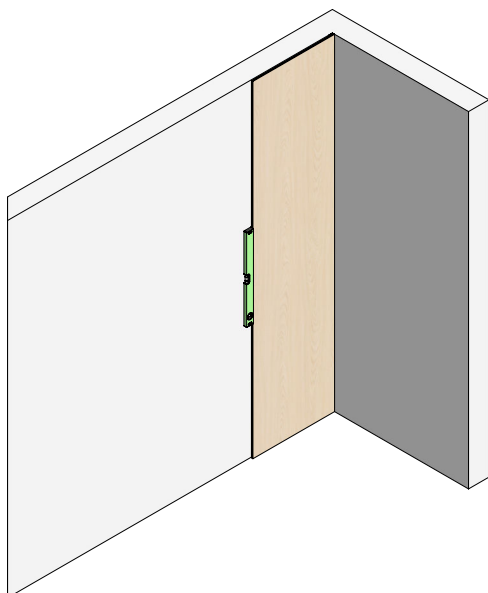

3. Insert the wall panel in the START profile. Double check that the wall panels are level using a spirit level.

Tip! Install our JOINT profile before you place the wall panel on the START profile.

WALL PANEL BETWEEN TWO EXISTING WALLS

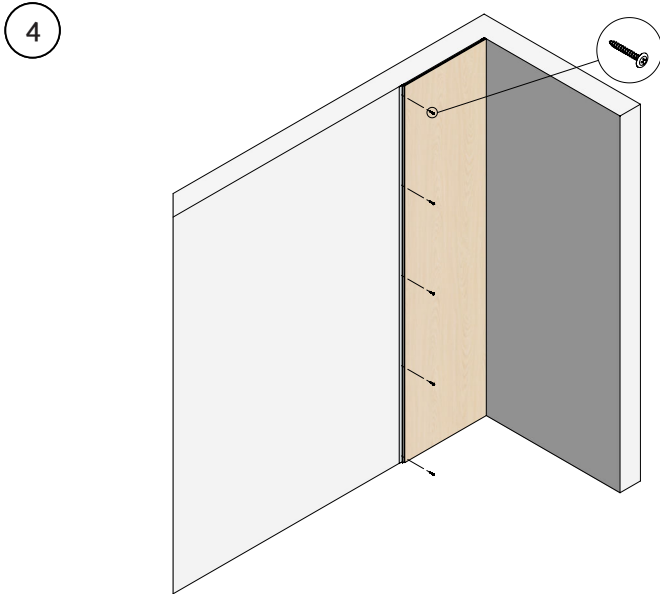

4.
Screw our aluminium JOINT profile onto the wall. Screw it into place keeping 50 mm from the upper edge and the lower edge, then evenly distribute the profiles in-between.

How many screws to use for the JOINT profile: 2,400 mm = 5 screws and 2,960 mm = 6 screws. Pre-drill holes in our profiles using a 5 mm drill bit before placing them on the wall.

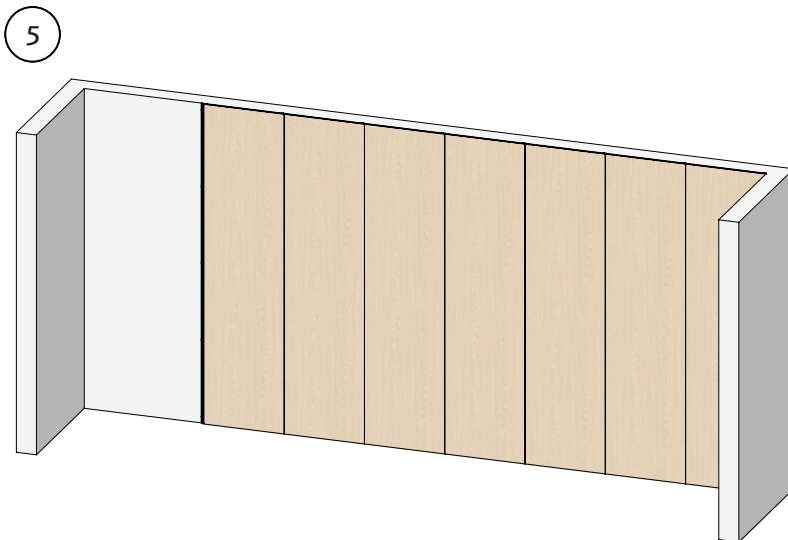

5.
Install the remaining wall panels in the same way using our JOINT profile. Except for the final two wall panels.

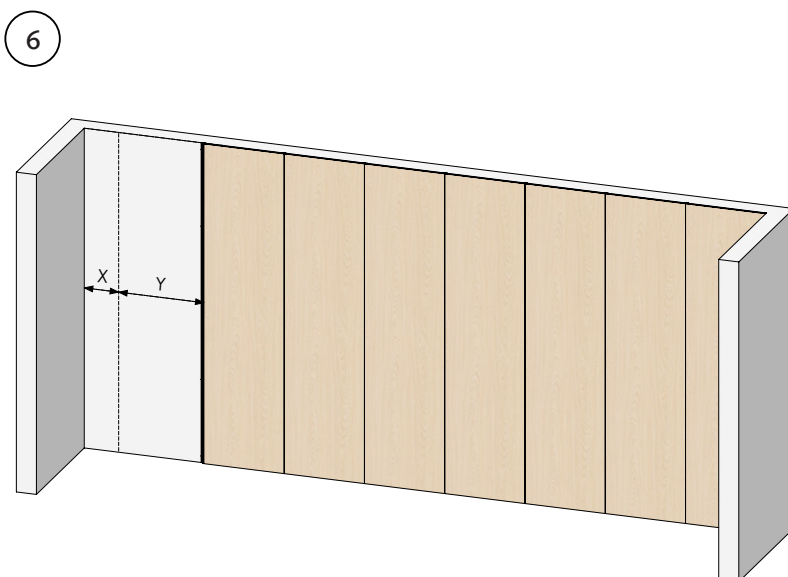

6.
Measure from the existing wall to the wall panel.

7

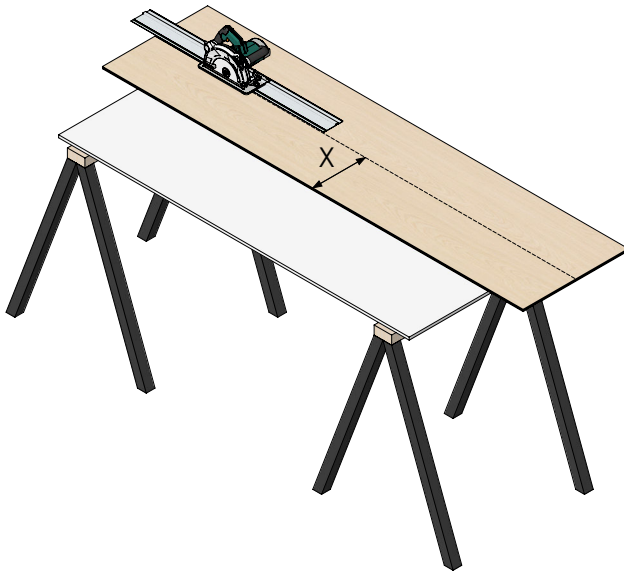

7. Saw the last wall panel at the correct width using a circular saw or a shadow gap saw.

8



8. Loosely fit this together using our JOINT PROFILE.

9

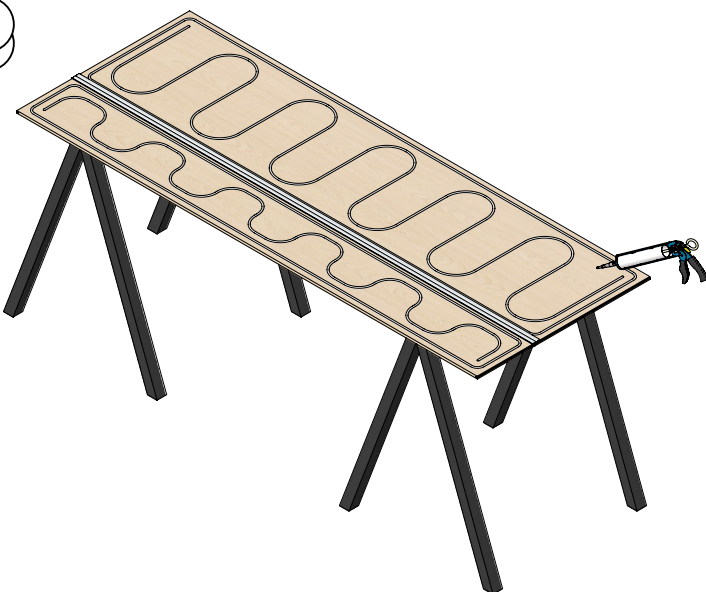

9. Glue the back side of the wall panels using our grab adhesive.

10

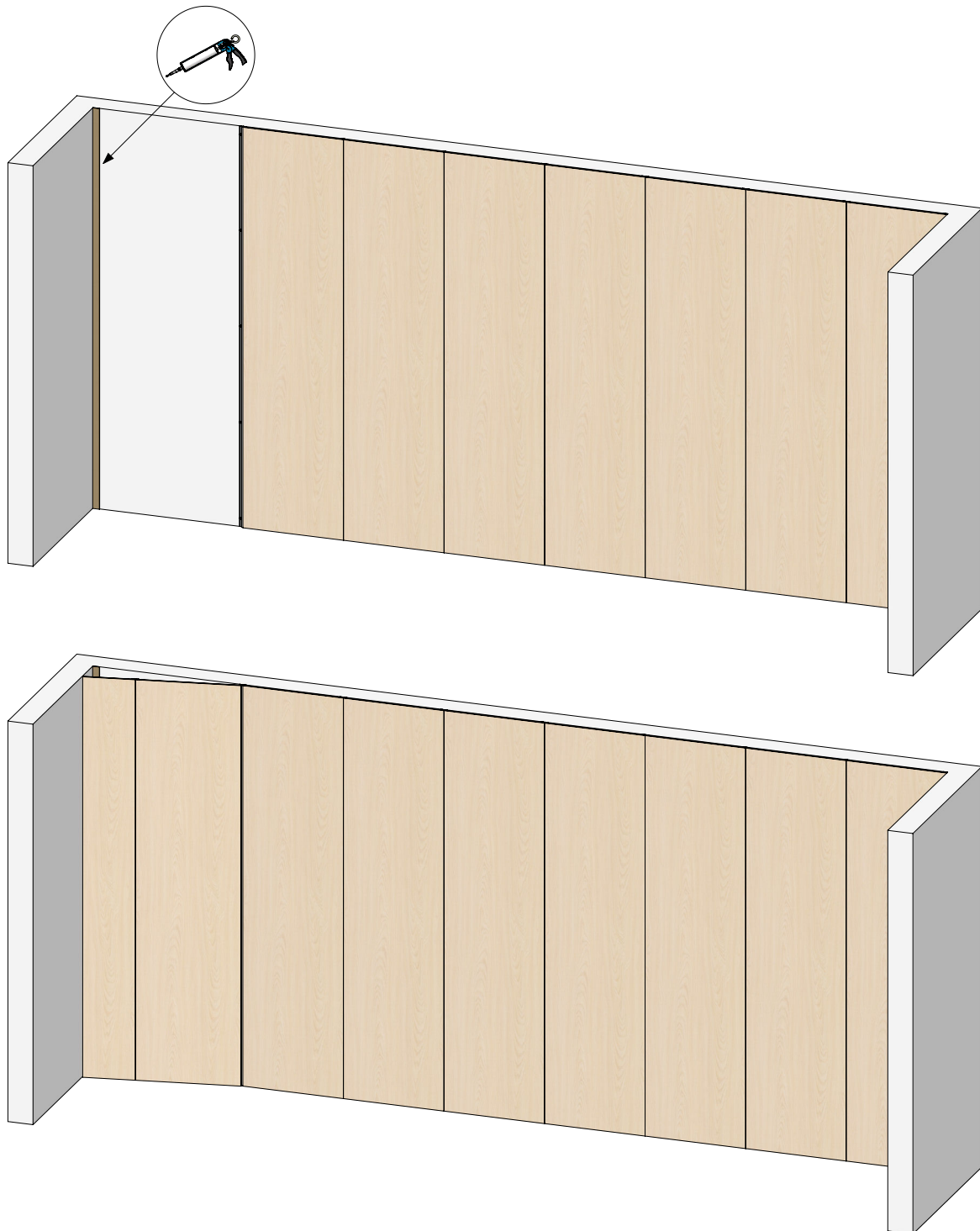

10.
Fold the two final panels together.

NOTE! Do not forget to screw or glue our SPACER strip into place behind the final wall panel beforehand, so that the distance between the wall panel and wall will be correct.

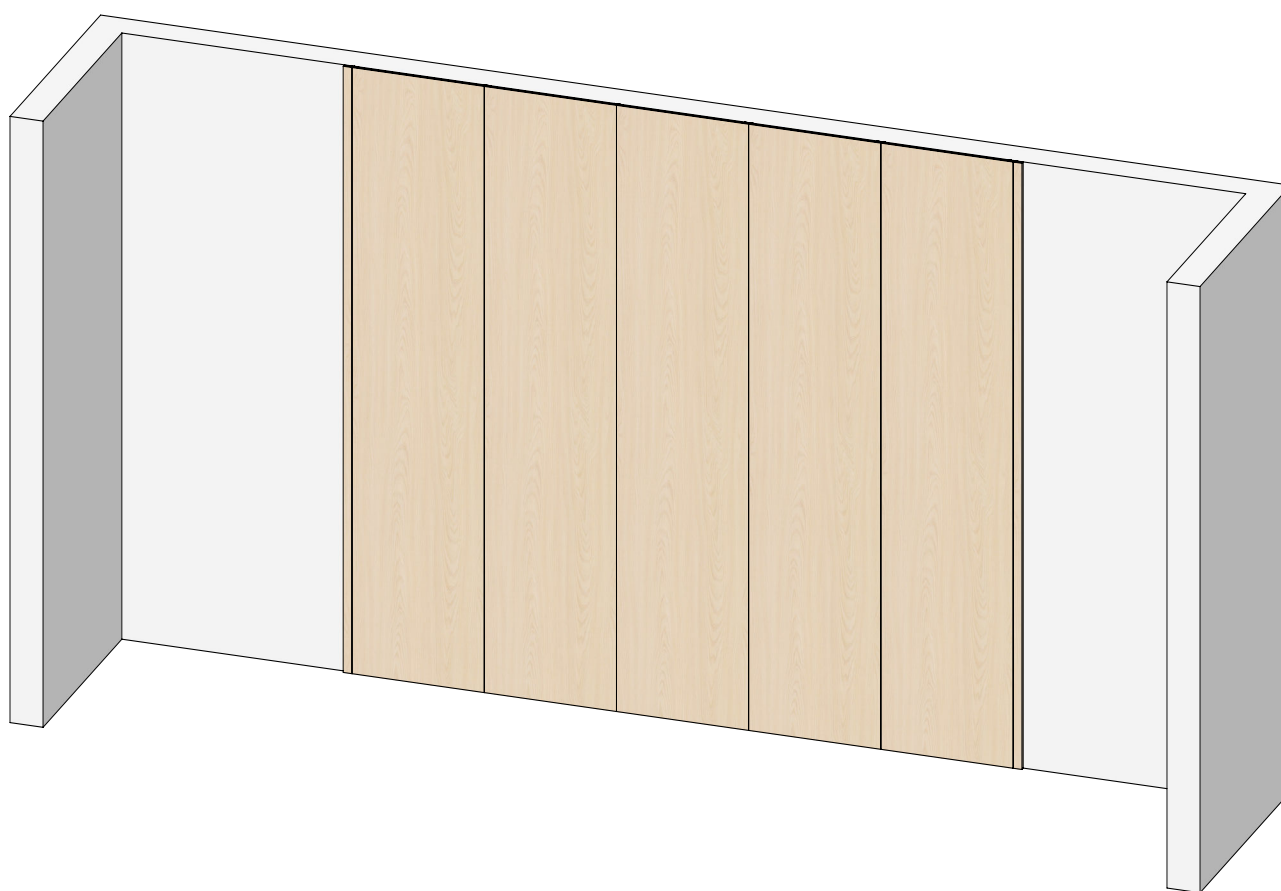

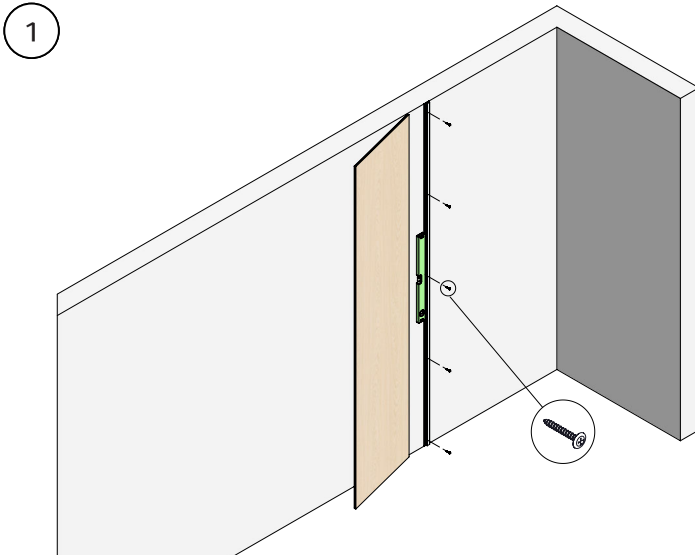

1. Screw our aluminium JOINT profile into place. Make sure the profile is level by using a spirit level.

NOTE! Keep in mind that our end strip is 37 mm wide. Screw the JOINT profile into place keeping 50 mm from the upper edge and the lower edge, then evenly distribute the profiles in-between.

How many screws to use for the JOINT profile: 2,400 mm = 5 screws and 2,960 mm = 6 screws. Pre-drill holes in our profiles using a 5 mm drill bit before placing them on the wall.



2. Measure the height of the existing wall. Saw the wall panel and the end strip at the correct height using a circular saw or a shadow gap saw.

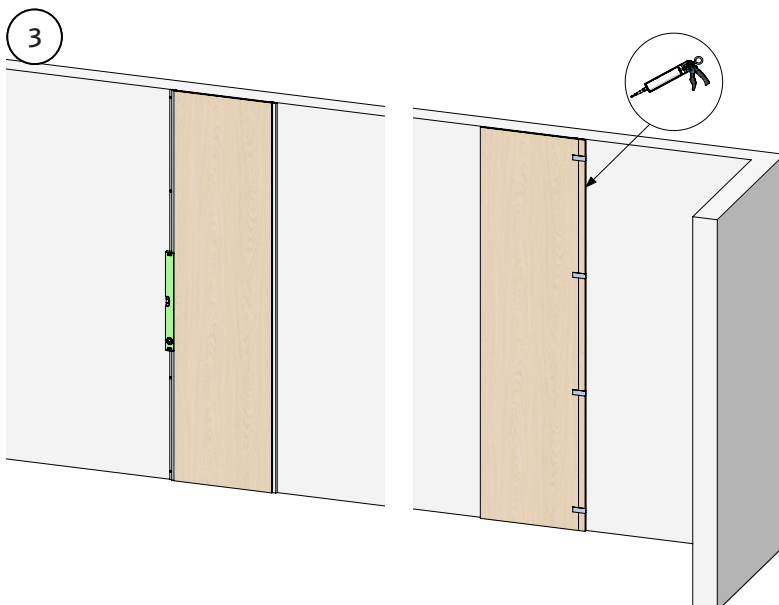

3. Place our grab adhesive on the end strip. Insert it into our JOINT profile.

Tape so that it is firmly placed against our wall panel and allow the glue to cure.

4

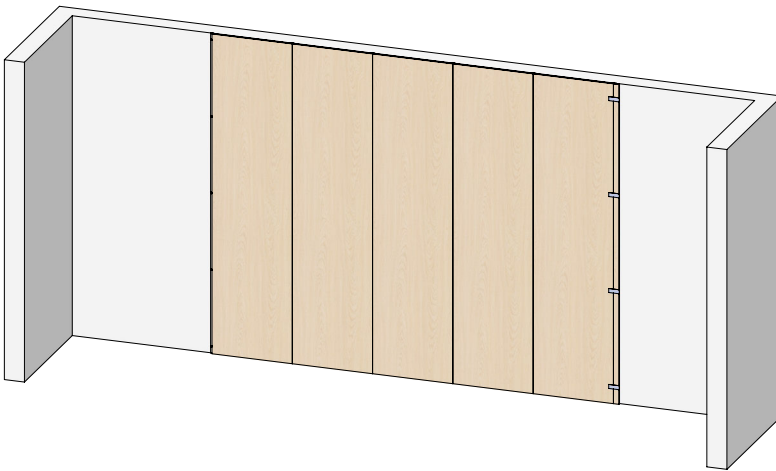

4.
Install the remaining wall panels in the same way using our JOINT profile.

5

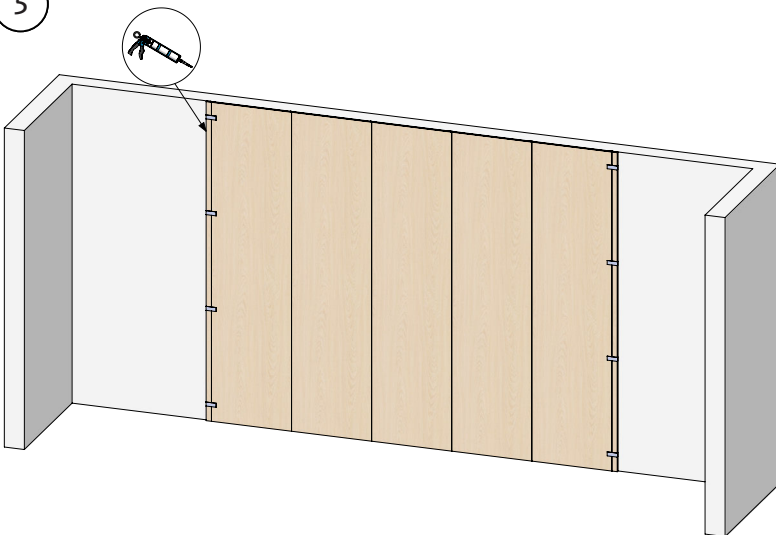

5.
Place our grab adhesive on the end strip. Insert it into our JOINT profile. Tape so that it is firmly placed against our wall panel and allow the glue to cure.

INSTALLING PANELS WITH OUTER CORNERS

VERSION 1



1



1. Installing outer corners. Mitre together the edges of two wall panels in the outer corner.
Set the circular saw at 45 degrees and saw the edges.

2

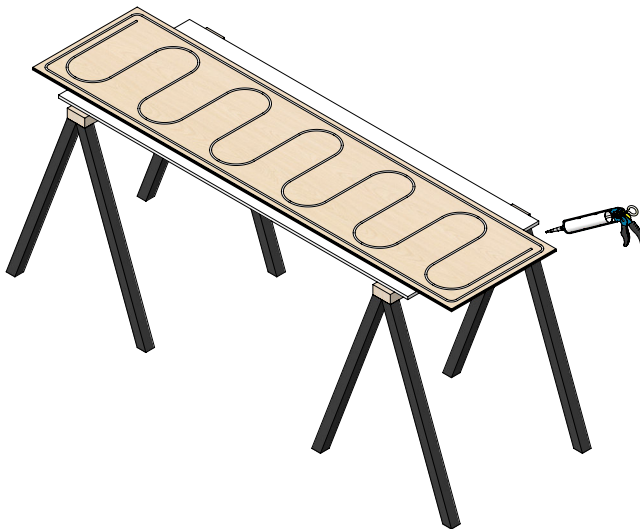

2. Glue the rear side of the wall panel using our grab adhesive.

3

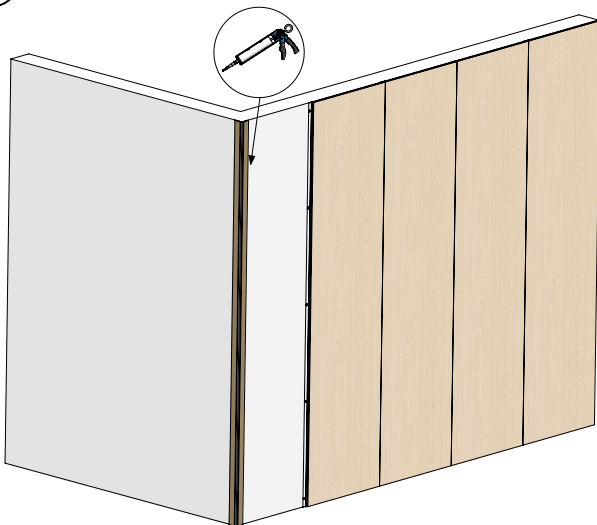

3. Screw or glue our SPACER strip into place before installing our wall panels so that the distance between our wall panel and the wall will be correct.

4

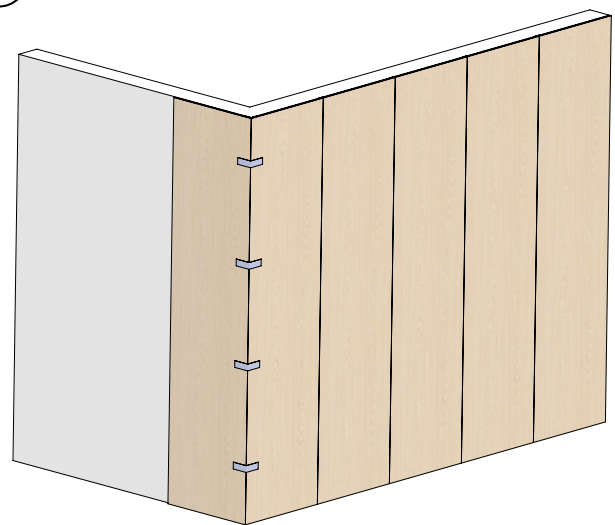

4. Once the panels are in place, tape them and allow the glue to cure.

Tip! If possible, begin installing from the outer corner.

INSTALLING PANELS WITH OUTER CORNERS

VERSION 2



1

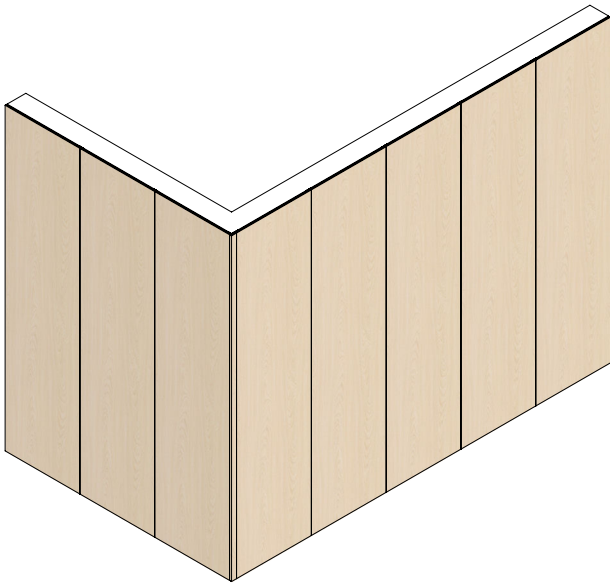

1. If there is an outside corner, always start from there.

2

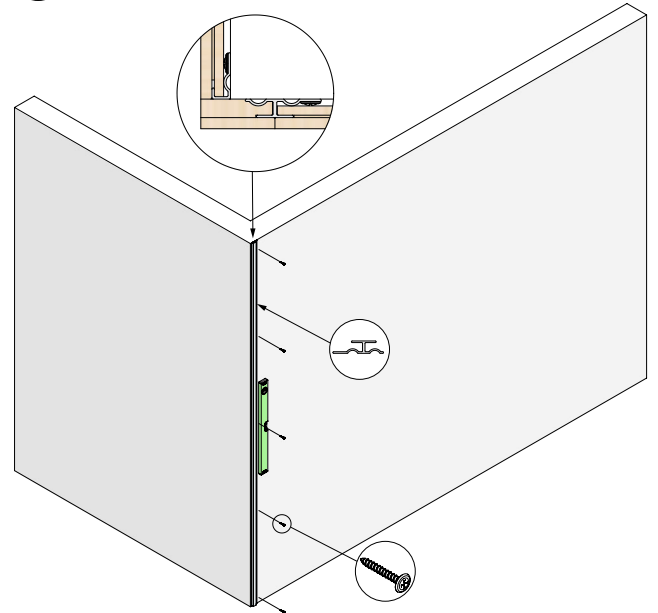

2. When installing an outer corner with a finishing strip, you start by installing a joint profile. Make sure that you go over the edge enough to cover both the wall panel and the gap before screwing on the SKARV profile and that it is straight.

3

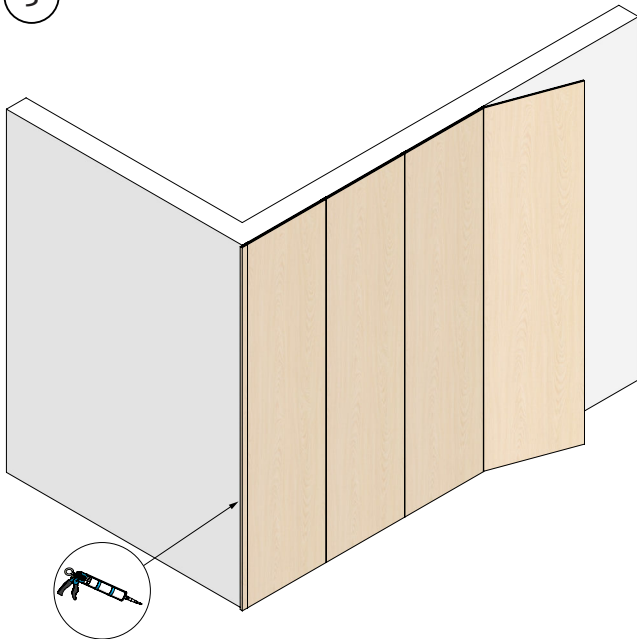

3. Glue with our mounting adhesive on the finishing strip. Insert it into our SKARV profile. Tape it against our wall panel and let the glue harden. You can continue installing that wall while the glue cures.

4

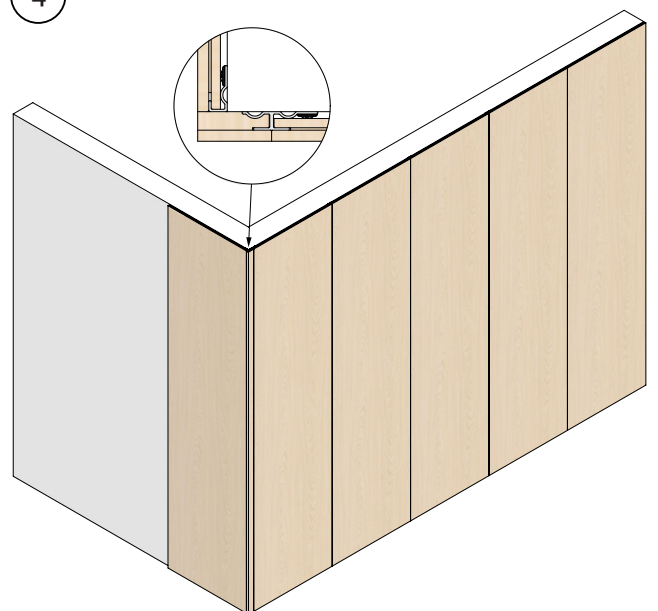

4. Then screw on the START profile and mount your wall panel.

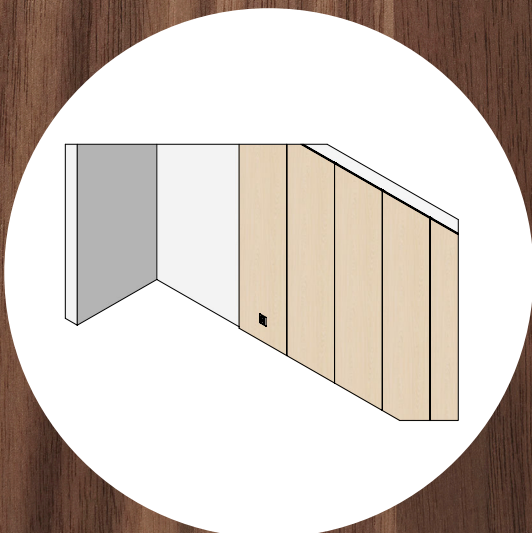

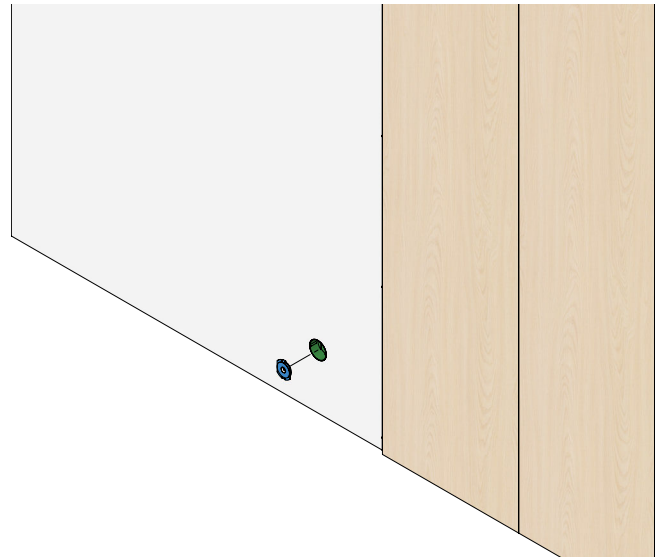
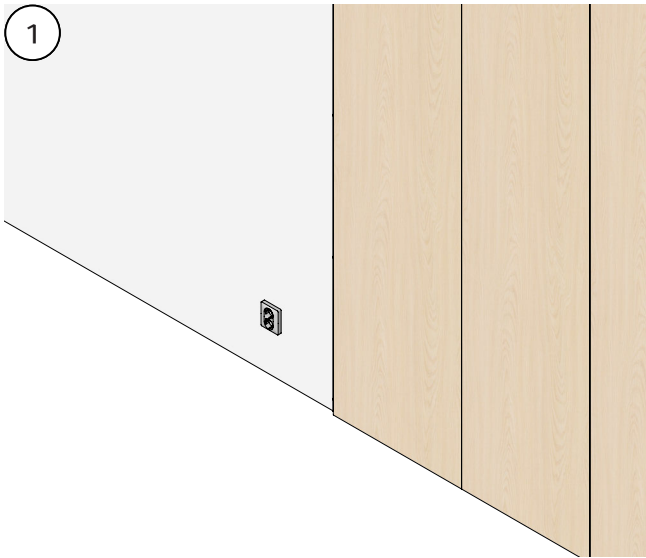

1. Externally mounted Electric switch/Plug socket/Spotlights Remove the electrical socket cover and fit a junction box insert.

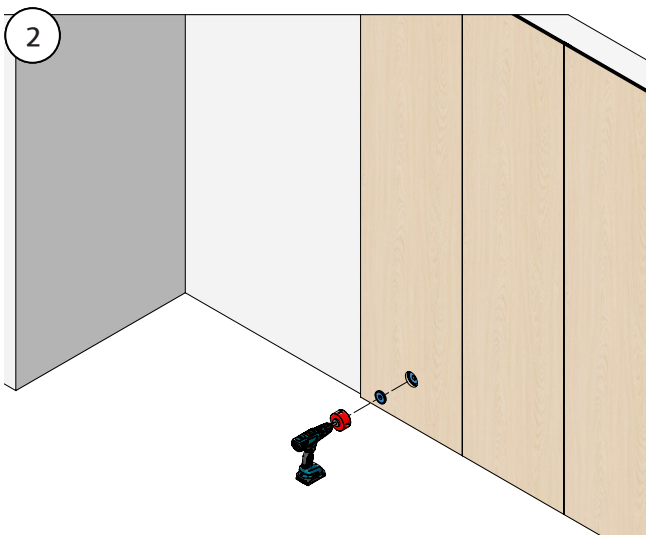

2. Then install the wall panel over the electric switch/plug socket/spotlights. Place the detector there so you can find where to drill the hole. Drill using a hole saw drill bit.

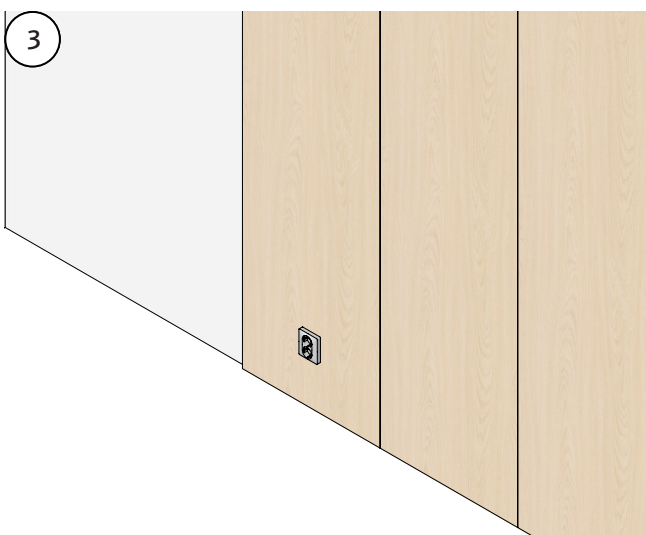

3. Install the electric switch/plug socket/the spotlight.

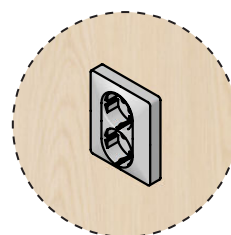

EXTERNALLY MOUNTED ELECTRICAL SOCKETS

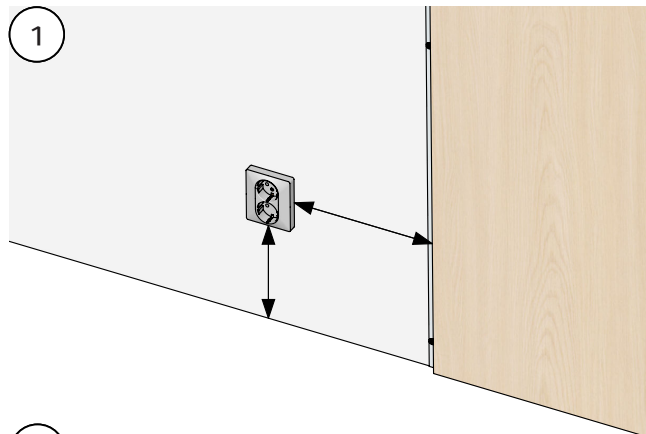
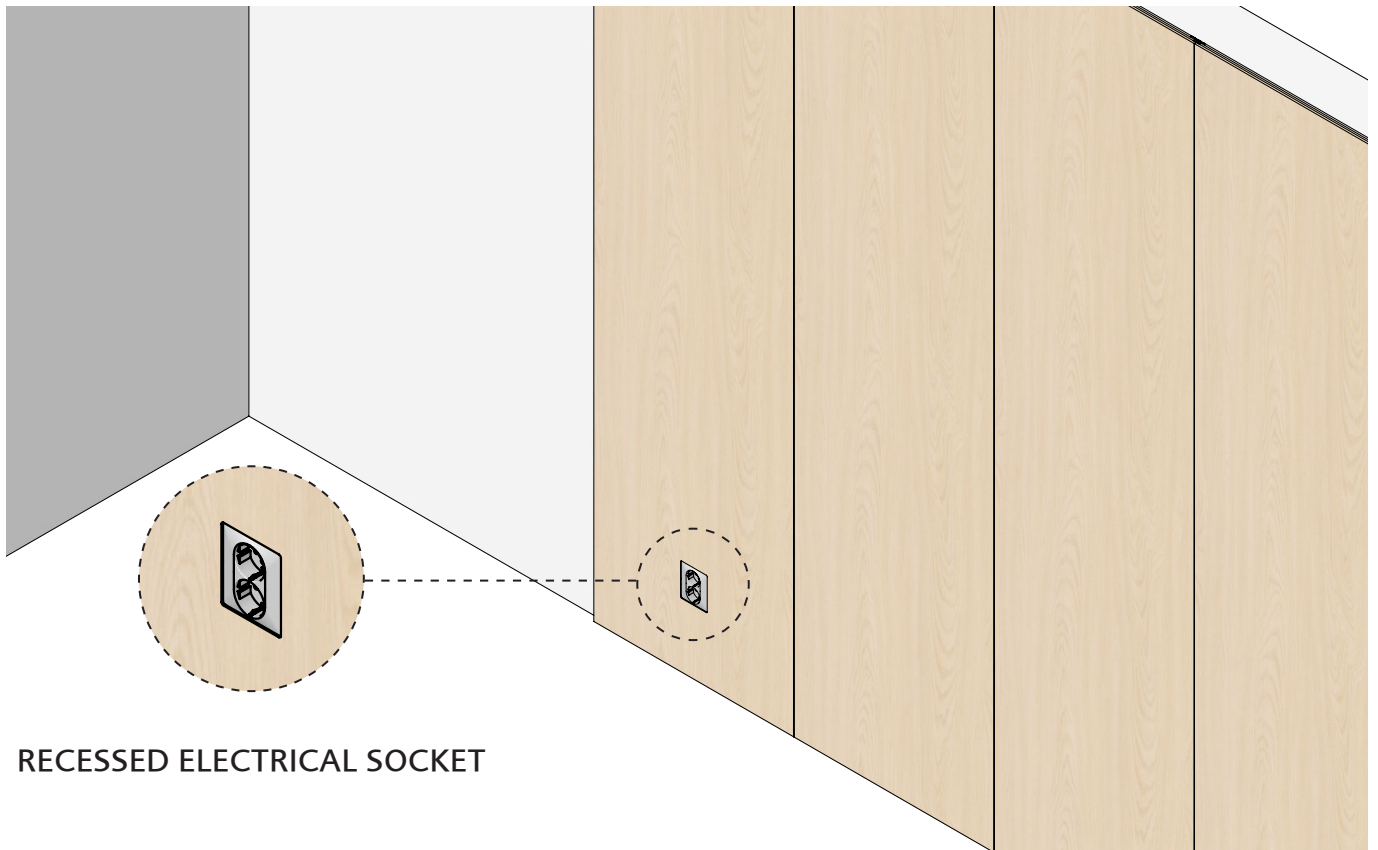

1.
Measure where the electric switch/plug socket/
the spotlight is placed on the wall in relation to the
wall panel.

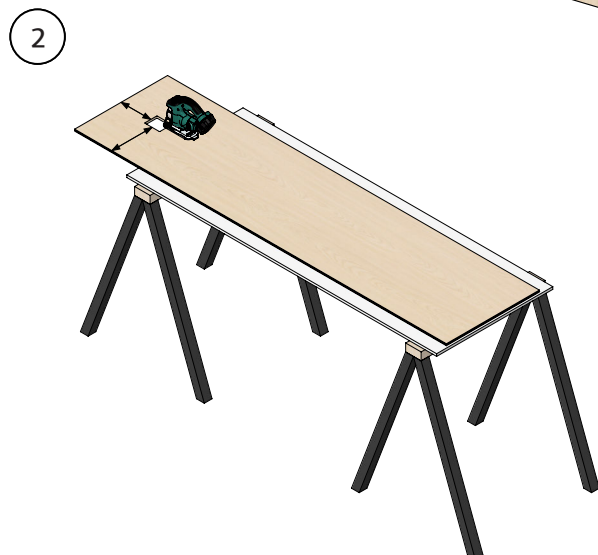

2.
Transfer the measurements to the panel and saw out
a hole using a compass saw.

3

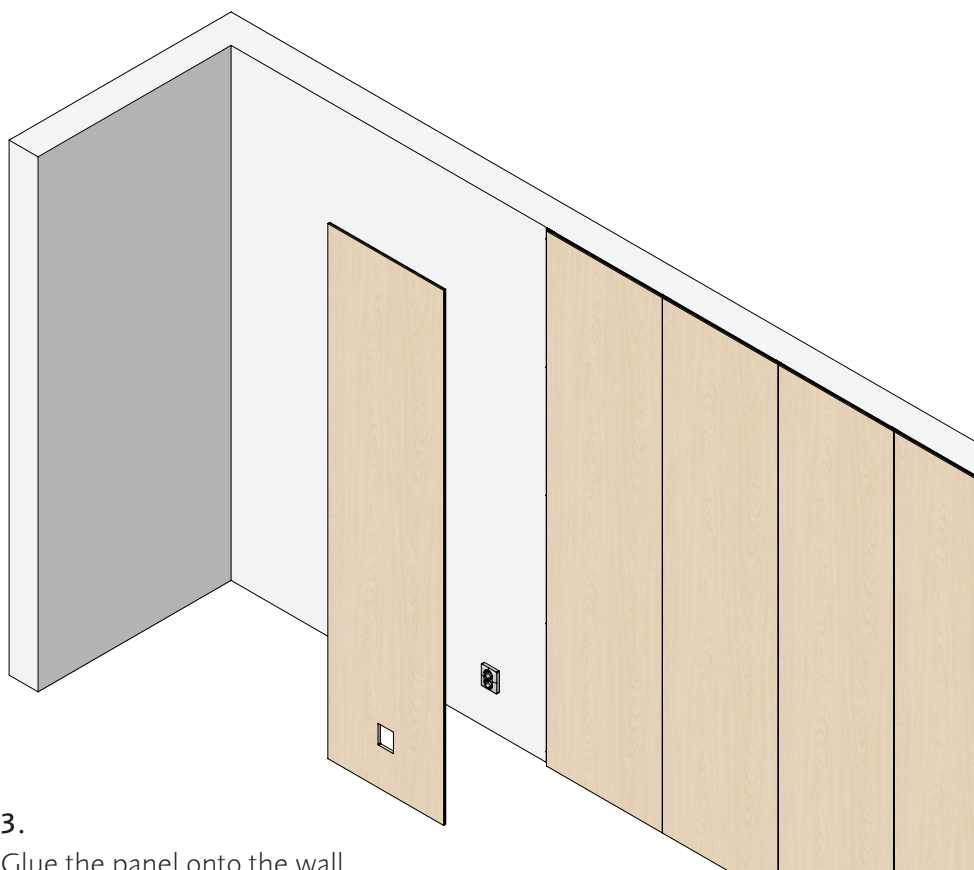

3.
Glue the panel onto the wall.

4

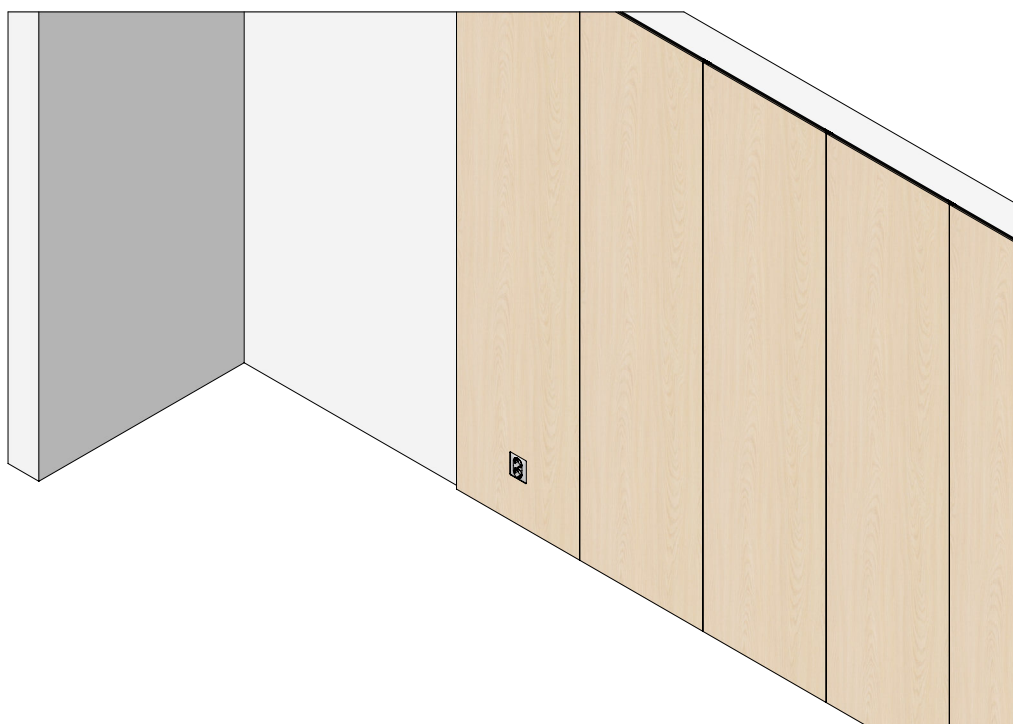

WALLSYSTEMS

Sture Steens Väg 9 | SE-341 55 Vittaryd

Tel.Nr: +46 140 412 25

Mejl: info@wallsystems.se

Hemsida: www.wallsystems.se